

VT.647BH

Our EPD Group 1 - Garda Range for Floor & Wall comes in hundreds of different designs, colours, slip ratings and finishes. Much of the range is accredited to rigorous eco-friendly standards (including LEED/BREEAM etc) to help specifiers meet the sustainability goals of their clients.



Bush Hammered

Properties



Other formats available



20mm
Paver

Other finishes available



Natural

Sizes available

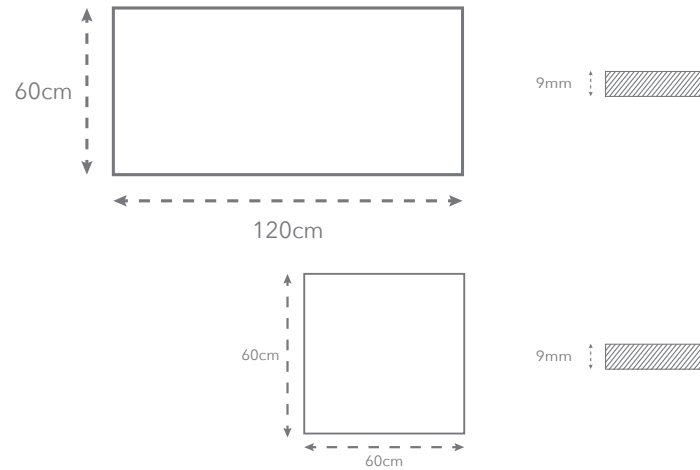

MOBILE SAMPLE LIBRARY REFERENCE



Stone Look
Full Bodied
EPD Group 1 - Garda Range



ECO FRIENDLY TILES®
The planet, covered

www.ecofriendlytiles.co.uk

Eco Friendly Tiles Ltd
Ground Floor, Solon House
40a Peterborough Road
London
SW6 3BN

0844 980 2233
info@ecofriendlytiles.co.uk

Technical Specification

Code: VT.647BH



Eco Friendly Tiles Ltd
 Ground Floor, Solon House
 40a Peterborough Road
 London
 SW6 3BN
 0844 980 2233
 info@ecofriendlytiles.co.uk
www.ecofriendlytiles.co.uk

Physical & chemical properties	Norm/test method	Required Standard	Results
Thickness	EN ISO 10545-2	± 5.0% Max	Complies
Straightness of Sides	EN ISO 10545-2	±0.3% Max	Complies
Rectangularity	EN ISO 10545-2	± 0.3% Max	Complies
Surface Flatness	EN ISO 10545-2	± 0.4% Max	Complies
Water absorption	EN ISO 10545-3	≤ 0.5%	≤ 0.1%
Flexion Resistance	EN ISO 10545-4	≥ 35 N/mm ²	≥ 48 N/mm ²
Impact Resistance	EN ISO 10545-5	-	> 0.80
Abraision Resistance	EN ISO 10545-6	≤ 175 mm ³	< 150 mm ³
Coefficient of Linear Thermal Expansion	EN ISO 10545-8	-	< 6.6*10 ⁻⁶ °C ⁻¹
Resistance to Thermal Shocks	EN ISO 10545-9	-	No damage
Frost Resistance	EN ISO 10545-12	-	No damage
Resistance to Chemicals	EN ISO 10545-13	B Minimum	A, LA, HA
Resistance to Stains	EN ISO 10545-14	-	5
Slip Resistance	DIN 51130	-	R11
Pendulum Test Value		-	PTV 36+

Certifications



This technical information sheet is not a guarantee of performance and is not a warranty, either explicit or implicit. Rather, it tries to summarize for the designer, installer or developer the technical data provided to Eco Friendly Tiles by the independent tile manufacturer. This information may not be applicable in all geographical areas. It is the responsibility of those individuals who are referring to this document to independently research and determine which tiles are suitable for a given project according to applicable British or International Standards and any governing legislative requirements. This document cannot be used as expert opinion, evidence or in any legal or administrative procedure unless authorized by Eco Friendly Tiles Ltd.