

VS.48

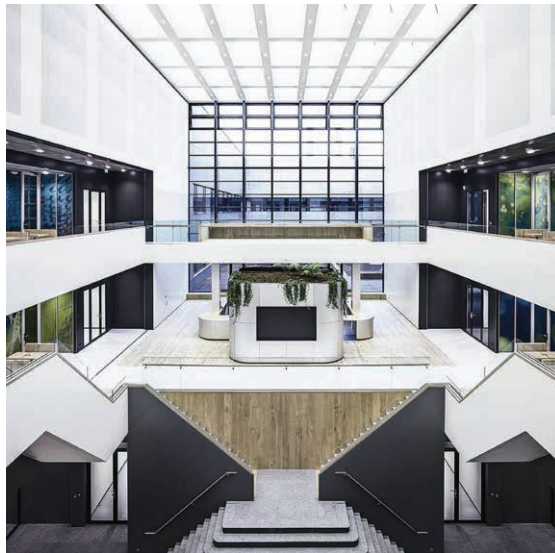













Ultra-thin - from just 3.5mm - yet so strong it can be laid in 3m x 1m slabs on floors, walls or as an overlay. With low embodied carbon, up to 40% pre-consumer recycled content, flexible sizes and over one hundred colours and finishes, it's time to join the surface revolution. With a LEED and EPD certifications, it's a range perfectly in step with 21st century living.

To see the full range or download the Brochure, visit: www.ecofriendlytiles.co.uk/eco/surface-brochure



Natural

Properties

 Carbon Offset	 Chemical Resistant	 Frost Resistant	 Thermal Shock Resistant	 More Colours Available	 BREEAM	 EPD	 LEED	 SKA	 ISO 14001	 R10	 PTV 36+ 5.6 only	 UP TO 50% Recycled Content	 Pre Consumer Recycled Content
--	---	--	---	---	---	--	---	--	--	--	--	---	---

Other formats

Other finishes

Sizes available in

3.5mm †  Wall (with mesh)

5.6mm ‡  Floor / Wall / Overlay

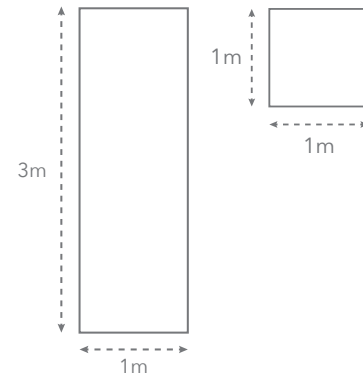

FOR OFFICE USE ONLY



Wood Look
Large Format
BREEAM/LEED



Facade Code: 048 Wood Grey
www.ecofriendlyfacades.co.uk



ECO FRIENDLY TILES®
The planet, covered

www.ecofriendlytiles.co.uk

Eco Friendly Tiles Ltd
Ground Floor, Solon House
40a Peterborough Road
London
SW6 3BN

0844 980 2233
info@ecofriendlytiles.co.uk
ecofriendlytiles.co.uk

Technical Specification

Code: VS.48



Eco Friendly Tiles Limited
Ground Floor, Solon House
40a Peterborough Road
London
SW6 3BN
0844 980 2233
info@ecofriendlytiles.co.uk
www.ecofriendlytiles.co.uk

Certifications



Physical & chemical properties	Norm/test method	Shannon 3.5mm	Shannon 5.6mm
Length & Width (1000x3000 mm)	ISO 10545-2	Max. deviation on the side +/- 0.5mm	Max. deviation on the side +/- 0.5mm
(1200x3000 mm)	ISO 10545-2	-	Minimum size: ≥ 1210x3050 mm
(1620x3240 mm)	ISO 10545-2	-	Minimum size: ≥ 1630x3250 mm
Difference between diagonals	Factory	Max. +/- 1.5mm	Max. +/- 1.5mm
Weight	Factory	Average value 8.2kg/m ²	Average value 14.5kg/m ²
Surface quality/% of tiles with no visible flaws	ISO 10545-2	> 95%	> 95%
Water absorption	ISO 10545-3 / ASTM C373	Average value 0.1%	Average Value ≤ 0.1%
Breaking strength in N (samples 200x300mm)	ISO 10545-4	Average value 700	Average value 1100
Modulus of rupture in N/mm ² (samples 200x300mm)	ISO 10454-4	Average value 50	Average value 50
Resistance to deep abrasion	ISO 10545-6	≤ 175mm ³	≤ 175mm ³
Coefficient of linear thermal expansion / 10 ⁻⁶ / 0 ^c	ISO 10545-8	Average value 6.6	Average value 6.6
Resistance to thermal shock	ISO 10545-9	Compliant	Compliant
Resistance to freeze-thaw	ISO 10545-12	Compliant	Compliant
Chemical resistance	ISO 10545-13	Class: from A to B	Class: from A to B
Stain resistance	ISO 10545-14	Class: from 4 to 5	Class: from 4 to 5
Coefficient of friction	DIN 51130	R10	R10
	BS 7976-2:2002 Pendulum	-	PTV 36+
Fire reaction	EN 13501 (rev. 2005)	A2 - s1, d0	A1 (decision 96/603/CE as amended)