

VT.363G

Our Cascade Range for Floor & Wall comes in hundreds of different designs, colours, slip ratings and finishes. Much of the range is accredited to rigorous eco-friendly standards (including LEED/BREEAM etc) to help specifiers meet the sustainability goals of their clients.



Grip

Properties



Other formats available

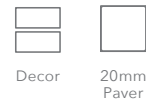

Other finishes available



Sizes available

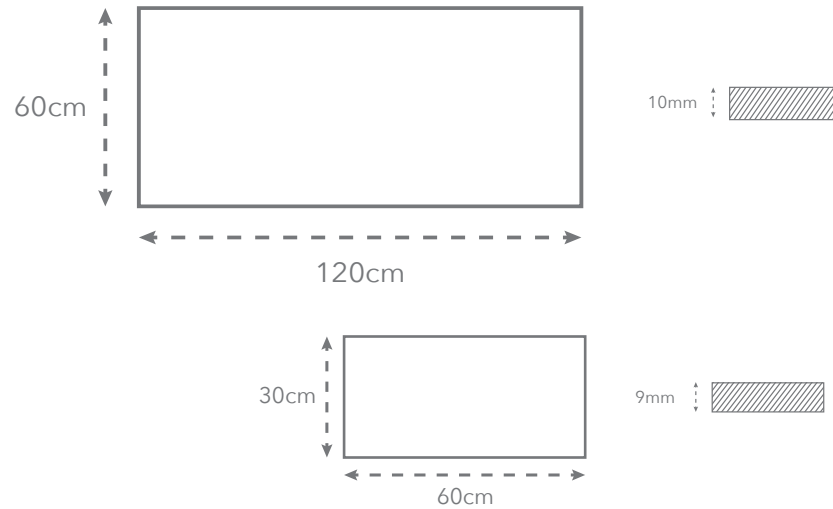

MOBILE SAMPLE LIBRARY REFERENCE



Stone Look
High Slip
Porcelain



ECO FRIENDLY TILES®
The planet, covered

www.ecofriendlytiles.co.uk

Eco Friendly Tiles Ltd
Ground Floor, Solon House
40a Peterborough Road
London
SW6 3BN

0844 980 2233
info@ecofriendlytiles.co.uk

Technical Specification

Code: VT.363G



Eco Friendly Tiles Ltd
 Ground Floor, Solon House
 40a Peterborough Road
 London
 SW6 3BN
 0844 980 2233
 info@ecofriendlytiles.co.uk
www.ecofriendlytiles.co.uk

Physical & chemical properties	Norm/test method	Required Standard	Results
Thickness	EN ISO 10545-2	± 5.0% / ± 0.5mm	Conforms
Straightness of sides	EN ISO 10545-2	± 0.5% / ± 1.5mm	Conforms
Rectangularity	EN ISO 10545-2	± 0.6% / ± 2.0mm	Conforms
Warpage	EN ISO 10545-2	± 0.5% / ± 2.0mm	Conforms
Water absorption	EN ISO 10545-3	≤ 0.5%	≤ 0.5%
Flexion Resistance	EN ISO 10545-4	AR ≥ 35 N/mm ²	≥ 35 N/mm ²
Crazing Resistance	EN ISO 10545-11	-	Required
Frost Resistance	EN ISO 10545-12	UB Min.	Required
Resistance to Chemicals	EN ISO 10545-13	UB Min.	GB Min.
Stain Resistance	EN ISO 10545-14	-	Class 3 min.
Slip Resistance	DIN 51130	-	R11
	BS 7976-2:2002 Pendulum	-	PTV 36+

Certifications



This technical information sheet is not a guarantee of performance and is not a warranty, either explicit or implicit. Rather, it tries to summarize for the designer, installer or developer the technical data provided to Eco Friendly Tiles by the independent tile manufacturer. This information may not be applicable in all geographical areas. It is the responsibility of those individuals who are referring to this document to independently research and determine which tiles are suitable for a given project according to applicable British or International Standards and any governing legislative requirements. This document cannot be used as expert opinion, evidence or in any legal or administrative procedure unless authorized by Eco Friendly Tiles Ltd.